

G8051S

NPN EPITAXIAL TRANSISTOR

LOW VOLTAGE HIGH CURRENT SMALL SIGNAL NPN TRANSISTOR

Description

The G8051S is a low voltage high current small signal NPN transistor, designed for Class B push-pull audio amplifier for portable radio and general purpose applications.

Features

- *Collector current up to 700mA
- *Collector –Emitter voltage up to 20V
- *Complementary to G8551S

Package Dimensions

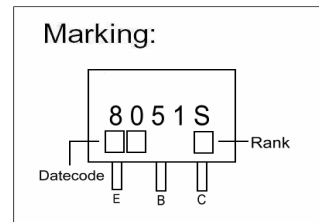
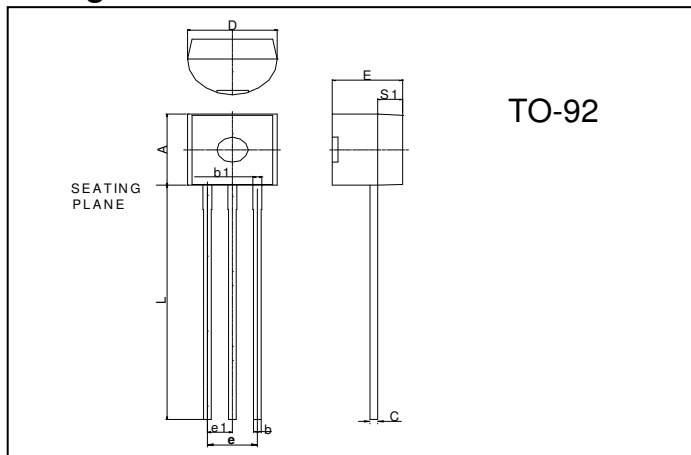

REF.	Millimeter		REF.	Millimeter	
	Min.	Max.		Min.	Max.
A	4.45	4.7	D	4.44	4.7
S1	1.02	-	E	3.30	3.81
b	0.36	0.51	L	12.70	-
b1	0.36	0.76	e1	1.150	1.390
C	0.36	0.51	e	2.42	2.66

Absolute Maximum Ratings (Ta = 25°C, unless otherwise specified)

Parameter		Ratings	Unit
Collector to Base Voltage	VCBO	25	V
Collector to Emitter Voltage	VCEO	20	V
Emitter to Base Voltage	VEBO	5	V
Collect Current(DC)	Ic	0.7	A
Junction Temperature	Tj	+150	°C
Storage Temperature Range	TSTG	-55 ~ +150	°C
Total Power Dissipation	PD	625	mW

Electrical Characteristics (Ta = 25°C, unless otherwise specified)

Symbol	Min.	Typ.	Max.	Unit	Test Conditions
BVCBO	25	-	-	V	Ic=10uA, IE=0
BVCEO	20	-	-	V	Ic=1mA, Ib=0
BVEBO	5	-	-	V	IE=10uA, Ic=0
ICBO	-	-	1	uA	VCB=20V, IE=0
IEBO	-	-	100	nA	VBE=6V, Ic=0
hFE1	100	-	400		VCE=1V, Ic=150mA
hFE2	-	100	-		VCE=1V, Ic=150mA
VCE(sat)	-	-	0.5	V	Ic=500mA, Ib=50mA
VBE(on)	-	-	1	V	VCE=1V, Ic=150mA
fT	150	-	-	MHz	VCE=10V, Ic=20mA, f=100MHz
Cob	-	10	-	pF	VCB=10V, IE=0A, f=1MHz

Classification Of hFE1

Rank	C	D	E
Range	100-180	160-300	250-400

Characteristics Curve

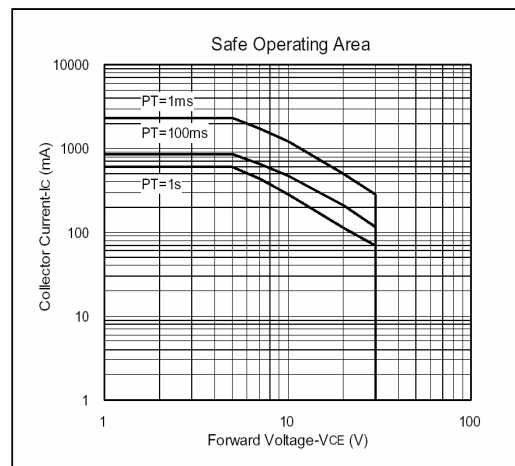
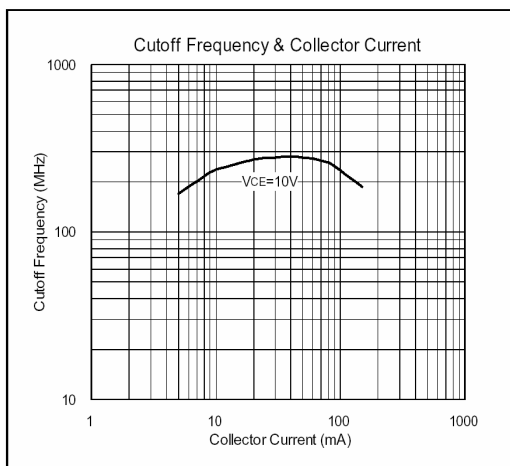
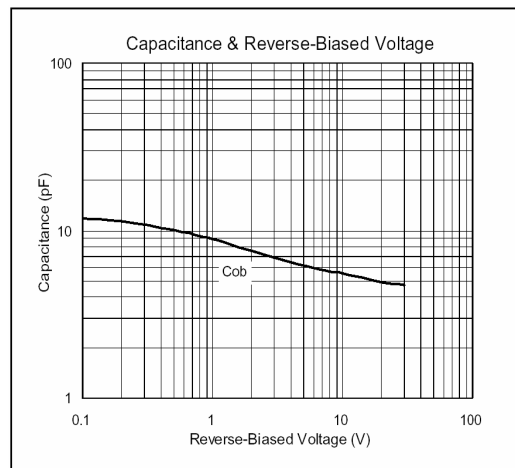
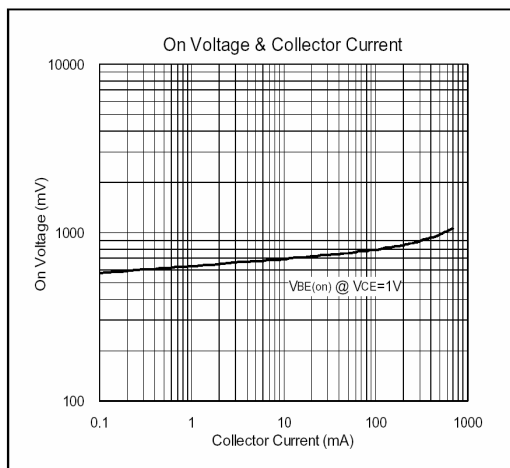
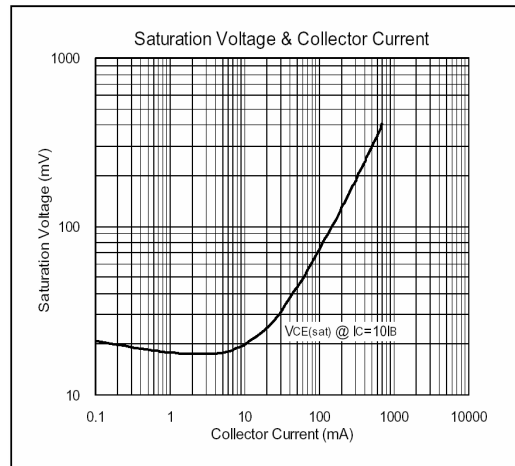
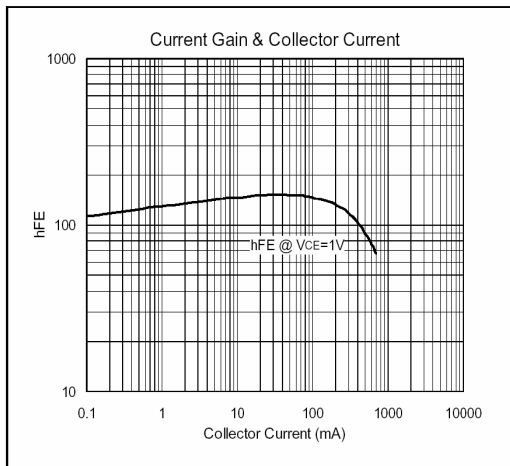

Important Notice:

- All rights are reserved. Reproduction in whole or in part is prohibited without the prior written approval of GTM.
- GTM reserves the right to make changes to its products without notice.
- GTM semiconductor products are not warranted to be suitable for use in life-support Applications, or systems.
- GTM assumes no liability for any consequence of customer product design, infringement of patents, or application assistance.

Head Office And Factory:

- **Taiwan:** No. 17-1 Tatung Rd. Fu Kou Hsin-Chu Industrial Park, Hsin-Chu, Taiwan, R. O. C.
- TEL : 886-3-597-7061 FAX : 886-3-597-9220, 597-0785
- **China:** (201203) No.255, Jang-Jiang Tsai-Lueng RD. , Pu-Dung-Hsin District, Shang-Hai City, China
- TEL : 86-21-5895-7671 ~ 4 FAX : 86-21-38950165