

GTS217E

N-CHANNEL ENHANCEMENT MODE POWER MOSFET

BVDSS	20V
RDS(ON)	22mΩ
ID	7A

Description

The GTS217E provides the designer with the best combination of fast switching, ruggedized device design, ultra low on-resistance and cost-effectiveness.

Features

- *Low on-resistance
- *Capable of 2.5V gate drive
- *Optimal DC/DC battery application

Package Dimensions

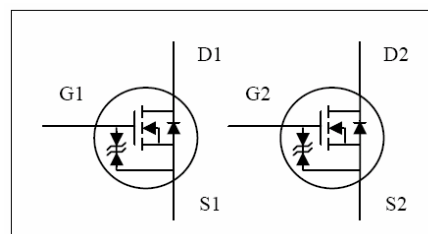
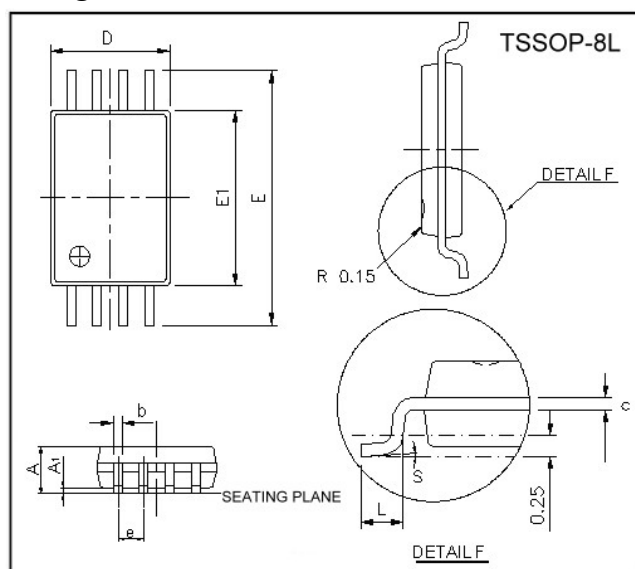

Marking:

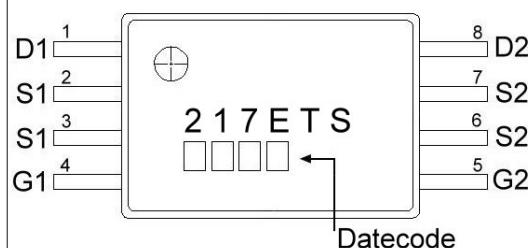

REF.	Millimeter		REF.	Millimeter	
	Min.	Max.		Min.	Max.
A	-	1.20	E	6.20	6.60
A1	0.05	0.15	E1	4.30	4.50
b	0.19	0.30	e	0.65 BSC	
c	0.09	0.20	L	0.45	0.75
D	2.90	3.10	S	0°	8°

Absolute Maximum Ratings

Parameter	Symbol	Ratings	Unit
Drain-Source Voltage	V_{DS}	20	V
Gate-Source Voltage	V_{GS}	± 12	V
Continuous Drain Current ³	$I_D @ TA=25^\circ C$	7	A
Continuous Drain Current ³	$I_D @ TA=70^\circ C$	5.7	A
Pulsed Drain Current ¹	I_{DM}	30	A
Total Power Dissipation	$P_D @ TA=25^\circ C$	1.5	W
Linear Derating Factor		0.012	W/°C
Operating Junction and Storage Temperature Range	T_j, T_{stg}	-55 ~ +150	°C

Thermal Data

Parameter	Symbol	Value	Unit
Thermal Resistance Junction-ambient ³ Max.	R_{thj-a}	83	°C/W

Electrical Characteristics (T_j = 25°C unless otherwise specified)

Parameter	Symbol	Min.	Typ.	Max.	Unit	Test Conditions
Drain-Source Breakdown Voltage	BV _{DSS}	20	-	-	V	V _{GS} =0, I _D =250uA
Gate Threshold Voltage	V _{GS(th)}	0.5	-	1.0	V	V _{DS} =V _{GS} , I _D =250uA
Forward Transconductance	g _{fs}	-	24	-	S	V _{DS} =5V, I _D =7A
Gate-Source Leakage Current	I _{GSS}	-	-	±10	uA	V _{GS} = ±10V
Drain-Source Leakage Current(T _j =25°C)	I _{DSS}	-	-	1	uA	V _{DS} =16V, V _{GS} =0
Drain-Source Leakage Current(T _j =55°C)		-	-	5	uA	V _{DS} =16V, V _{GS} =0
Static Drain-Source On-Resistance	R _{DS(ON)}	-	-	22	mΩ	V _{GS} =4.5V, I _D =6.6A
		-	-	30		V _{GS} =2.5V, I _D =5.5A
Total Gate Charge ²	Q _g	-	9.3	-	nC	I _D =7A V _{DS} =10V V _{GS} =4.5V
Gate-Source Charge	Q _{gs}	-	0.6	-		
Gate-Drain ("Miller") Change	Q _{gd}	-	3.6	-		
Turn-on Delay Time ²	T _{d(on)}	-	820	-	ns	V _{DS} =10V I _D =1A V _{GS} =4.5V R _G =6Ω R _L =10Ω
Rise Time	T _r	-	934	-		
Turn-off Delay Time	T _{d(off)}	-	860	-		
Fall Time	T _f	-	510	-		
Input Capacitance	C _{iss}	-	231	-	pF	V _{GS} =0V V _{DS} =10V f=1.0MHz
Output Capacitance	C _{oss}	-	164	-		
Reverse Transfer Capacitance	C _{rss}	-	137	-		

Source-Drain Diode

Parameter	Symbol	Min.	Typ.	Max.	Unit	Test Conditions
Forward On Voltage ²	V _{SD}	-	-	1.0	V	I _S =1.0A, V _{GS} =0V
Reverse Recovery Time ²	T _{rr}	-	15.2	-	ns	I _S =7A, V _{GS} =0V dI/dt=100A/μs
Reverse Recovery Charge	Q _{rr}	-	6.3	-	nC	
Continuous Source Current (Body Diode)	I _S	-	-	2.5	A	V _D =V _G =0V, V _S =1.0V

Notes: 1. Pulse width limited by Max. junction temperature.

2. Pulse width ≤ 300us, duty cycle ≤ 2%.

3. Surface mounted on FR4 board, t ≤ 10sec.

Characteristics Curve

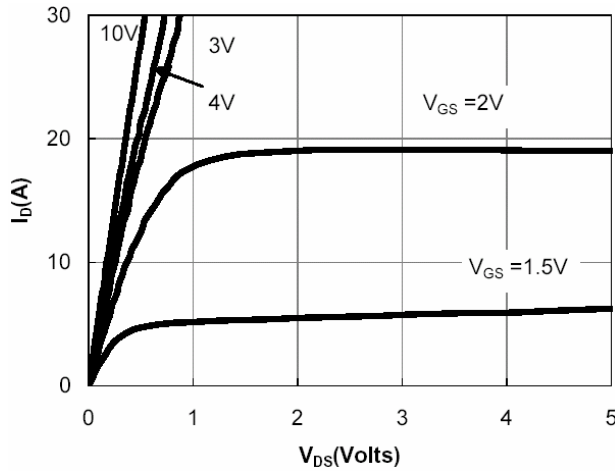

Fig 1. Typical Output Characteristics

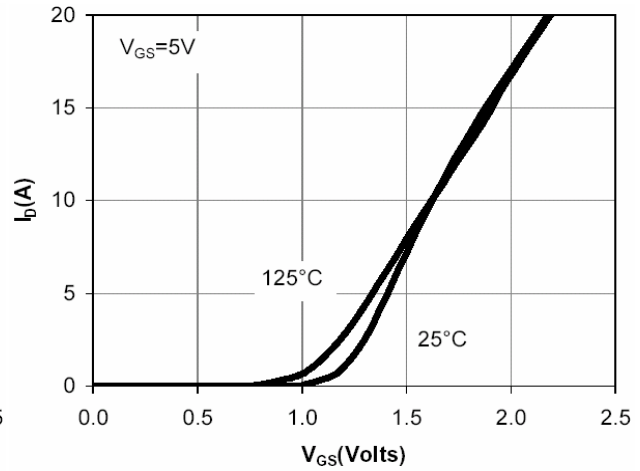

Fig 2. Transfer Characteristics

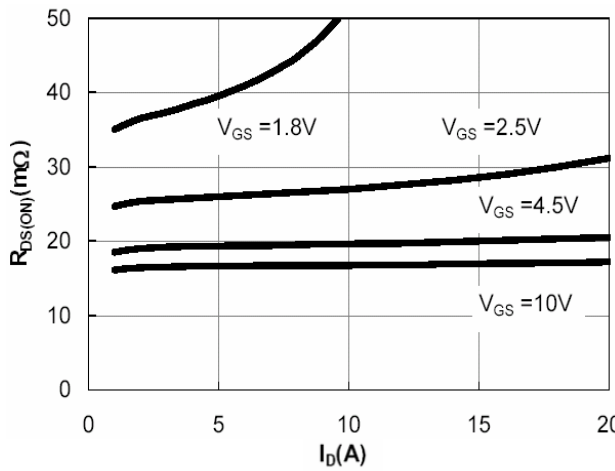

Fig 3. On-Resistance v.s. Drain Current and Gate Voltage

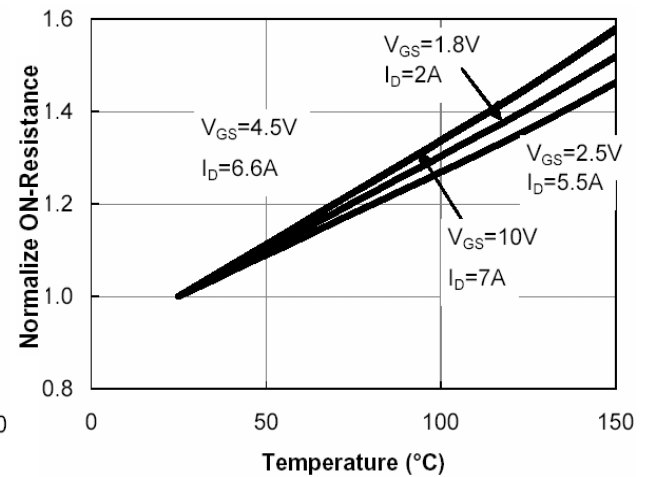

Fig 4. On-Resistance v.s. Junction Temperature

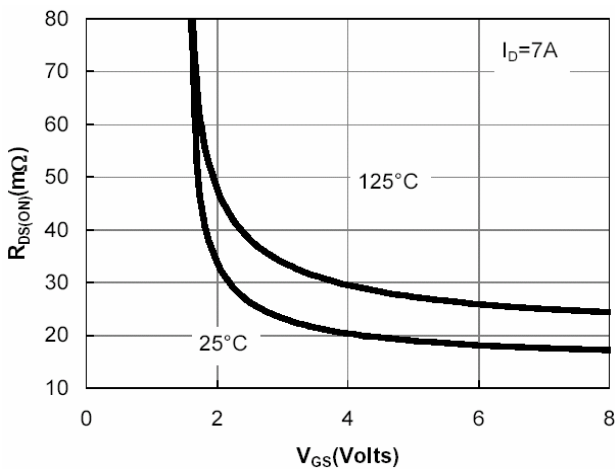

Fig 5. On-Resistance v.s. Gate-Source Voltage

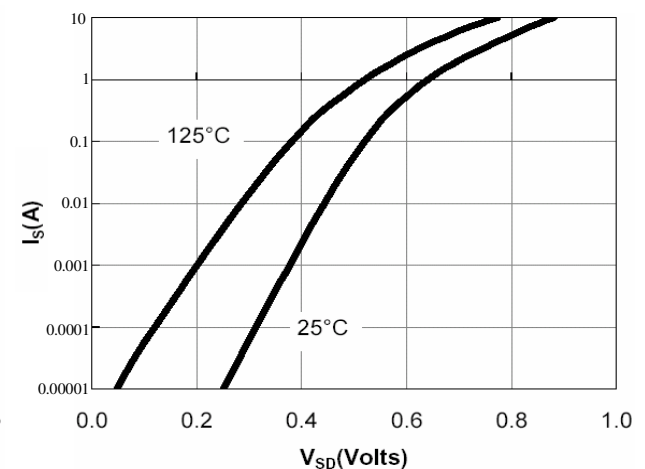

Fig 6. Body Diode Characteristics

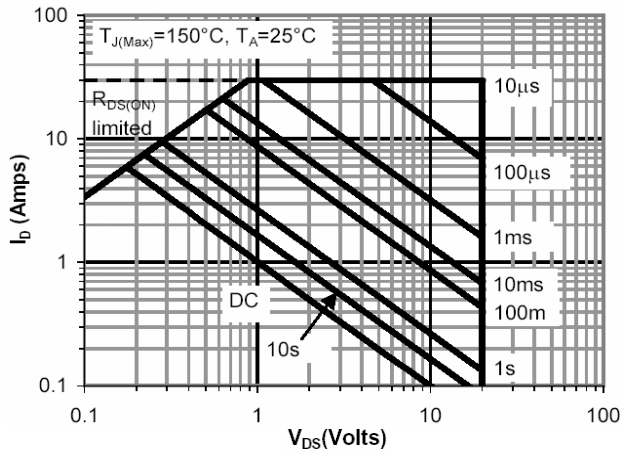

Fig 7. Maximum Safe Operating Area

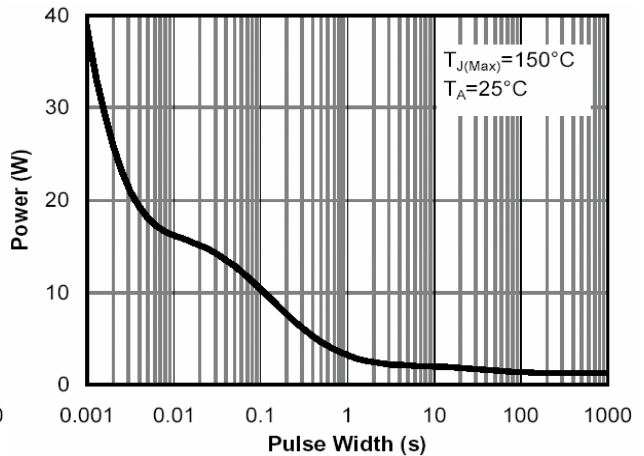

Fig 8. Single Pulse Power Rating Junction-to-Ambient

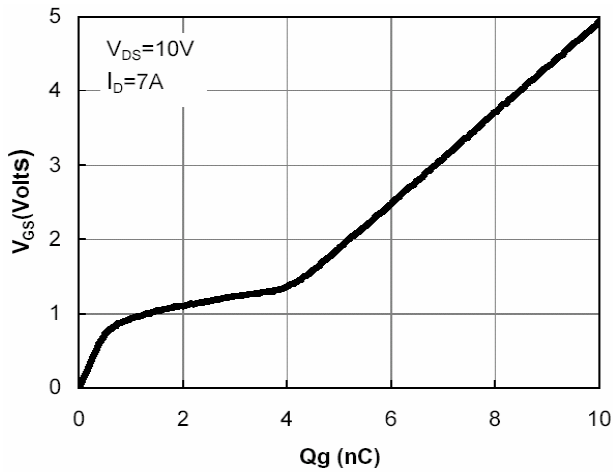

Fig 9. Gate Charge Characteristics

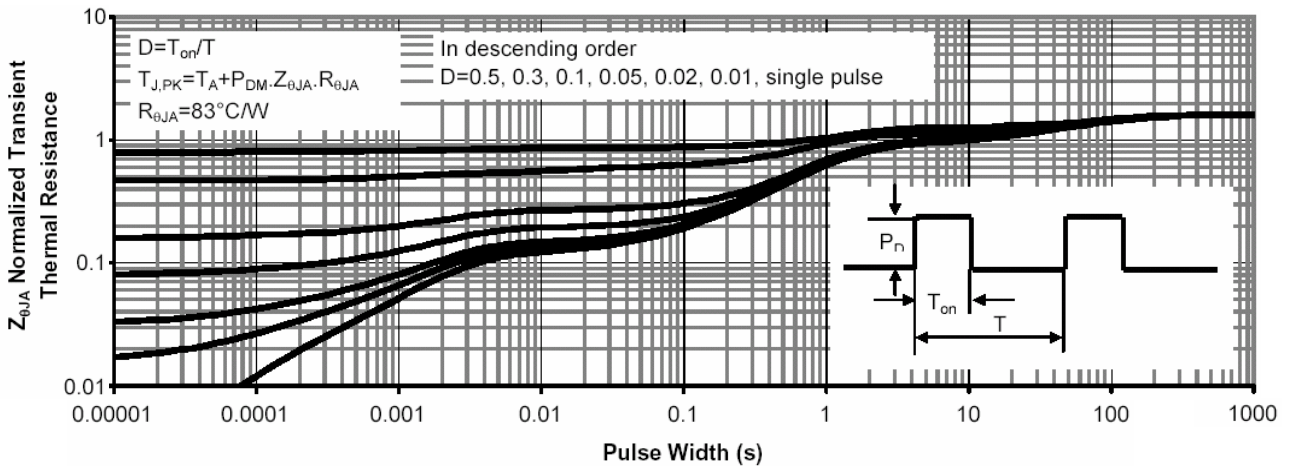

Fig 10. Normalized Maximum Transient Thermal Impedance

Important Notice:

- All rights are reserved. Reproduction in whole or in part is prohibited without the prior written approval of GTM.
- GTM reserves the right to make changes to its products without notice.
- GTM semiconductor products are not warranted to be suitable for use in life-support Applications, or systems.
- GTM assumes no liability for any consequence of customer product design, infringement of patents, or application assistance.

Head Office And Factory:

- **Taiwan:** No. 17-1 Tatung Rd. Fu Kou Hsin-Chu Industrial Park, Hsin-Chu, Taiwan, R. O. C.
- TEL : 886-3-597-7061 FAX : 886-3-597-9220, 597-0785
- **China:** (201203) No.255, Jang-Jiang Tsai-Lueng RD. , Pu-Dung-Hsin District, Shang-Hai City, China
- TEL : 86-21-5895-7671 ~ 4 FAX : 86-21-38950165