

## GU70L02

### N-CHANNEL ENHANCEMENT MODE POWER MOSFET

|         |     |
|---------|-----|
| BVDSS   | 25V |
| RDS(ON) | 9mΩ |
| ID      | 66A |

### Description

The GU70L02 provide the designer with the best combination of fast switching, ruggedized device design, low on-resistance and cost-effectiveness.

The TO-263 package is universally preferred for all commercial-industrial surface mount applications and suited for low voltage applications such as DC/DC converters.

### Features

- \*Simple Drive Requirement
- \*Low Gate Charge
- \*Fast Switching

### Package Dimensions

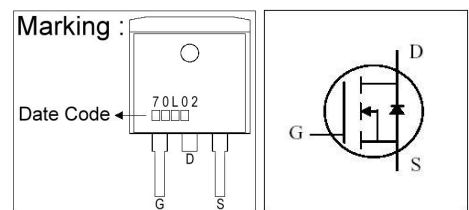
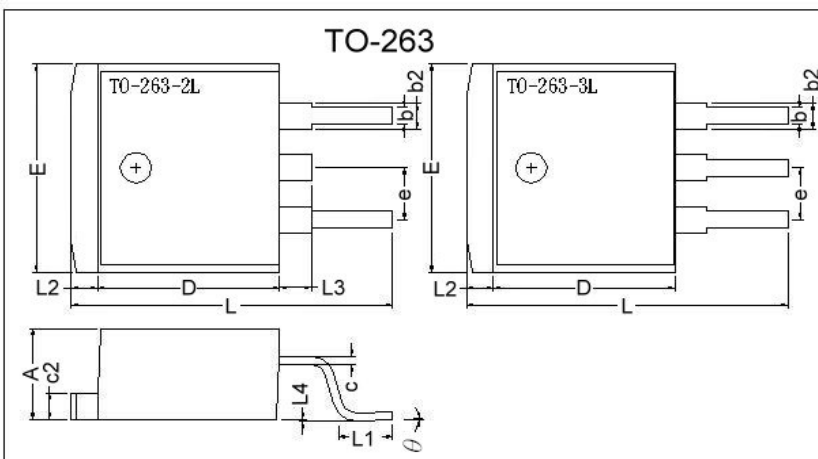

| REF. | Millimeter |      | REF. | Millimeter |      |
|------|------------|------|------|------------|------|
|      | Min.       | Max. |      | Min.       | Max. |
| A    | 4.40       | 4.80 | c2   | 1.25       | 1.45 |
| b    | 0.76       | 1.00 | b2   | 1.17       | 1.47 |
| L4   | 0.00       | 0.30 | D    | 8.6        | 9.0  |
| c    | 0.36       | 0.5  | e    | 2.54 REF.  |      |
| L3   | 1.50 REF.  |      | L    | 14.6       | 15.8 |
| L1   | 2.29       | 2.79 | θ    | 0°         | 8°   |
| E    | 9.80       | 10.4 | L2   | 1.27 REF.  |      |

### Absolute Maximum Ratings

| Parameter  | Symbol                  | Ratings    | Unit |
|--|-------------------------|------------|------|
| Drain-Source Voltage                             | $V_{DS}$                | 25         | V    |
| Gate-Source Voltage                              | $V_{GS}$                | ±20        | V    |
| Continuous Drain Current, $V_{GS}@10V$           | $I_D @T_C=25^{\circ}C$  | 66         | A    |
| Continuous Drain Current, $V_{GS}@10V$           | $I_D @T_C=100^{\circ}C$ | 42         | A    |
| Pulsed Drain Current <sup>1</sup>                | $I_{DM}$                | 210        | A    |
| Total Power Dissipation                          | $P_D @T_C=25^{\circ}C$  | 66         | W    |
| Linear Derating Factor                           |                         | 0.53       | W/°C |
| Operating Junction and Storage Temperature Range | $T_j, T_{stg}$          | -55 ~ +150 | °C   |

### Thermal Data

| Parameter                                | Symbol    | Value | Unit |
|--|-----------|-------|------|
| Thermal Resistance Junction-case Max.    | Rthj-case | 1.9   | °C/W |
| Thermal Resistance Junction-ambient Max. | Rthj-amb  | 62    | °C/W |

**Electrical Characteristics (T<sub>j</sub> = 25°C unless otherwise specified)**

| Parameter   | Symbol                         | Min. | Typ.  | Max. | Unit | Test Conditions  |
|---|--------------------------------|------|-------|------|------|--|
| Drain-Source Breakdown Voltage                      | BV <sub>DSS</sub>              | 25   | -     | -    | V    | V <sub>GS</sub> =0, I <sub>D</sub> =250uA  |
| Breakdown Voltage Temperature Coefficient           | $\Delta BV_{DSS} / \Delta T_j$ | -    | 0.037 | -    | V/°C | Reference to 25°C, I <sub>D</sub> =1mA   |
| Gate Threshold Voltage                              | V <sub>GS(th)</sub>            | 1.0  | -     | 3.0  | V    | V <sub>DS</sub> =V <sub>GS</sub> , I <sub>D</sub> =250uA   |
| Forward Transconductance                            | g <sub>fs</sub>                | -    | 25    | -    | S    | V <sub>DS</sub> =10V, I <sub>D</sub> =33A  |
| Gate-Source Leakage Current                         | I <sub>GSS</sub>               | -    | -     | ±100 | nA   | V <sub>GS</sub> = ±20V   |
| Drain-Source Leakage Current(T <sub>j</sub> =25°C)  | I <sub>DSS</sub>               | -    | -     | 1    | uA   | V <sub>DS</sub> =25V, V <sub>GS</sub> =0   |
| Drain-Source Leakage Current(T <sub>j</sub> =150°C) |                                | -    | -     | 25   | uA   | V <sub>DS</sub> =20V, V <sub>GS</sub> =0   |
| Static Drain-Source On-Resistance                   | R <sub>DS(ON)</sub>            | -    | -     | 9    | mΩ   | V <sub>GS</sub> =10V, I <sub>D</sub> =33A  |
|   |                                | -    | -     | 18   |      | V <sub>GS</sub> =4.5V, I <sub>D</sub> =20A   |
| Total Gate Charge <sup>2</sup>                      | Q <sub>g</sub>                 | -    | 23    | -    | nC   | I <sub>D</sub> =33A<br>V <sub>DS</sub> =20V<br>V <sub>GS</sub> =5V   |
| Gate-Source Charge                                  | Q <sub>gs</sub>                | -    | 3     | -    |      |  |
| Gate-Drain ("Miller") Charge                        | Q <sub>gd</sub>                | -    | 17    | -    |      |  |
| Turn-on Delay Time <sup>2</sup>                     | T <sub>d(on)</sub>             | -    | 8.8   | -    | ns   | V <sub>DS</sub> =15V<br>I <sub>D</sub> =33A<br>V <sub>GS</sub> =10V<br>R <sub>G</sub> =3.3Ω<br>R <sub>D</sub> =0.45Ω |
| Rise Time   | T <sub>r</sub>                 | -    | 95    | -    |      |  |
| Turn-off Delay Time                                 | T <sub>d(off)</sub>            | -    | 24    | -    |      |  |
| Fall Time   | T <sub>f</sub>                 | -    | 14    | -    |      |  |
| Input Capacitance                                   | C <sub>iss</sub>               | -    | 790   | -    | pF   | V <sub>GS</sub> =0V<br>V <sub>DS</sub> =25V<br>f=1.0MHz  |
| Output Capacitance                                  | C <sub>oss</sub>               | -    | 475   | -    |      |  |
| Reverse Transfer Capacitance                        | C <sub>rss</sub>               | -    | 195   | -    |      |  |

**Source-Drain Diode**

| Parameter                                       | Symbol          | Min. | Typ. | Max. | Unit | Test Conditions  |
|---|-----------------|------|------|------|------|--|
| Forward On Voltage <sup>2</sup>                 | V <sub>SD</sub> | -    | -    | 1.26 | V    | I <sub>S</sub> =66A, V <sub>GS</sub> =0V, T <sub>j</sub> =25°C |
| Continuous Source Current (Body Diode)          | I <sub>S</sub>  | -    | -    | 66   | A    | V <sub>D</sub> =V <sub>G</sub> =0V, V <sub>S</sub> =1.26V      |
| Pulsed Source Current (Body Diode) <sup>1</sup> | I <sub>SM</sub> | -    | -    | 210  | A    |  |

Notes: 1. Pulse width limited by safe operating area.

2. Pulse width ≤ 300us, duty cycle ≤ 2%.

## Characteristics Curve

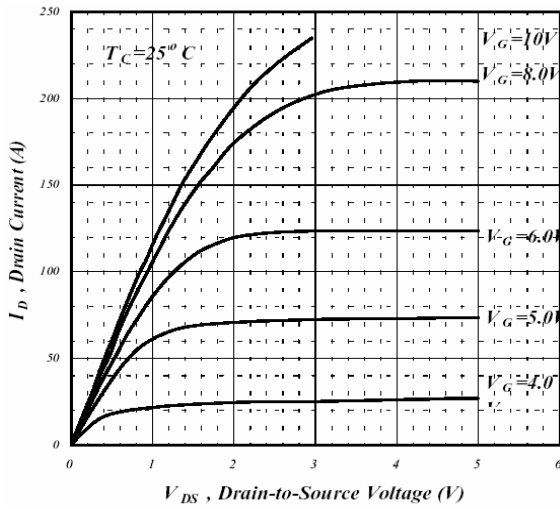

**Fig 1. Typical Output Characteristics**

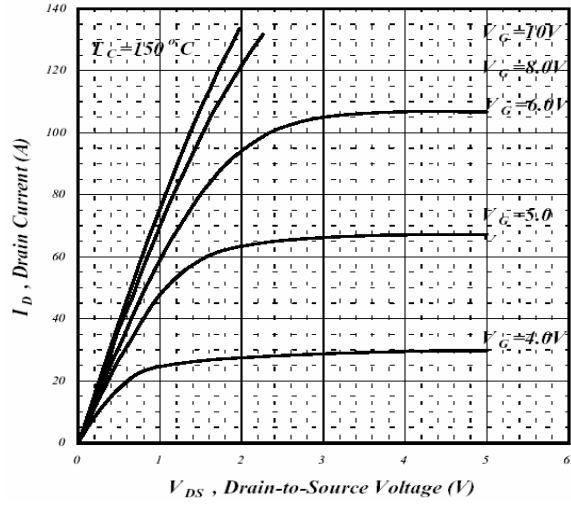

**Fig 2. Typical Output Characteristics**

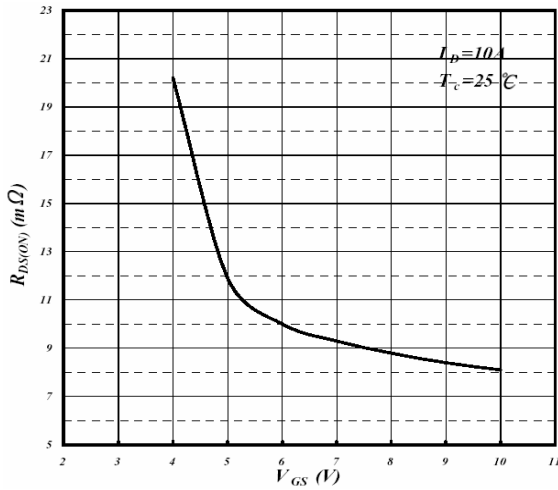

**Fig 3. On-Resistance v.s. Gate Voltage**

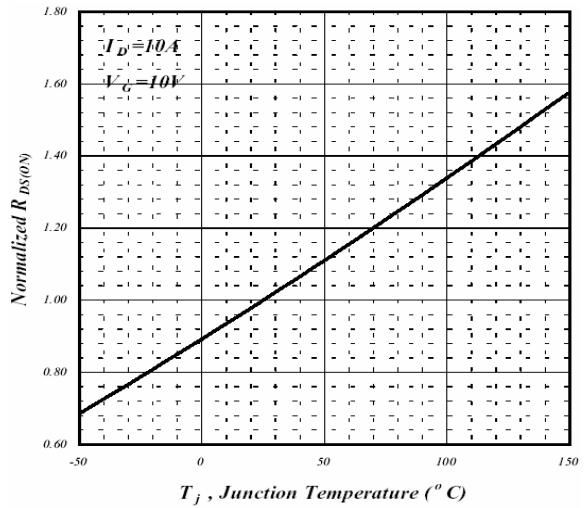

**Fig 4. Normalized On-Resistance v.s. Junction Temperature**

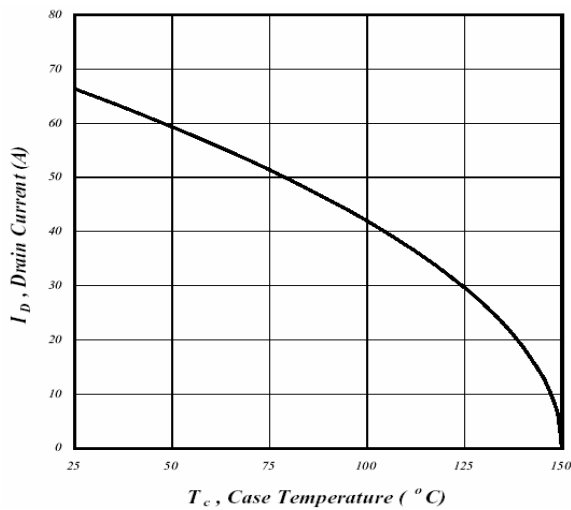

**Fig 5. Maximum Drain Current v.s. Case Temperature**

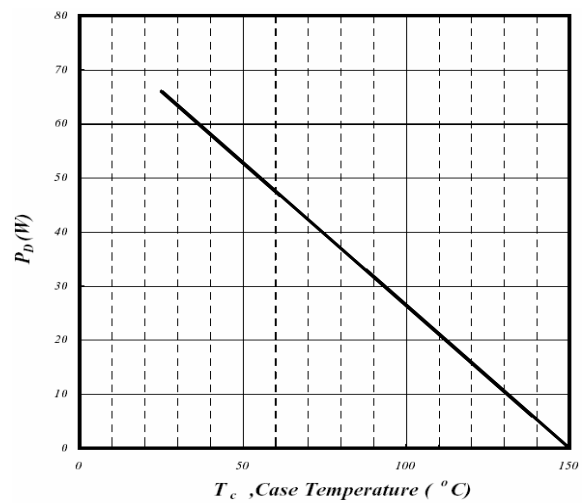

**Fig 6. Type Power Dissipation**

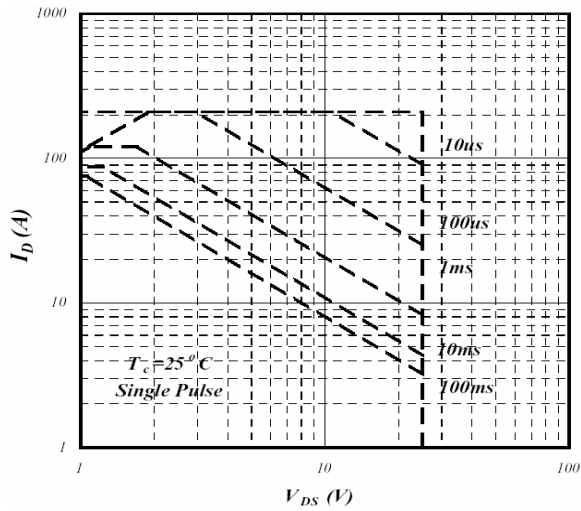

**Fig 7. Maximum Safe Operating Area**

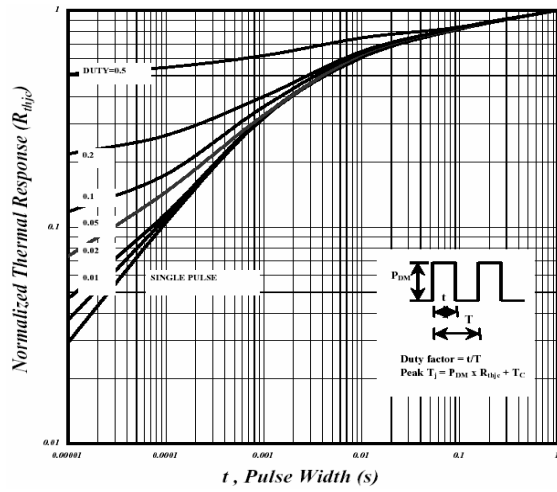

**Fig 8. Effective Transient Thermal Impedance**

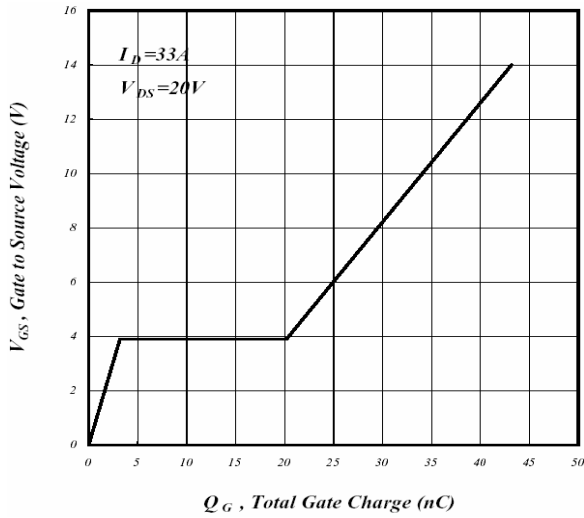

**Fig 9. Gate Charge Characteristics**

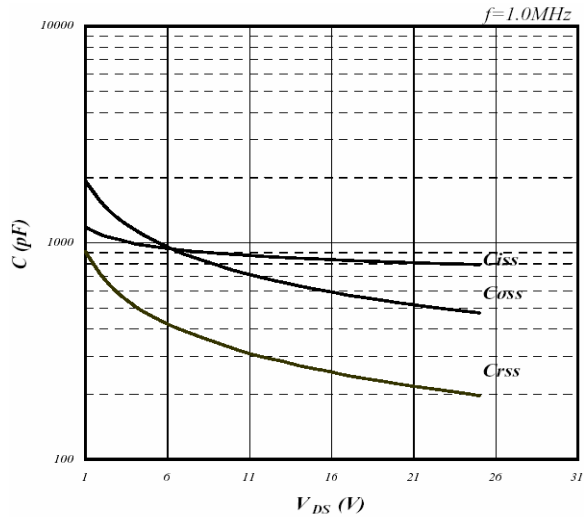

**Fig 10. Typical Capacitance Characteristics**

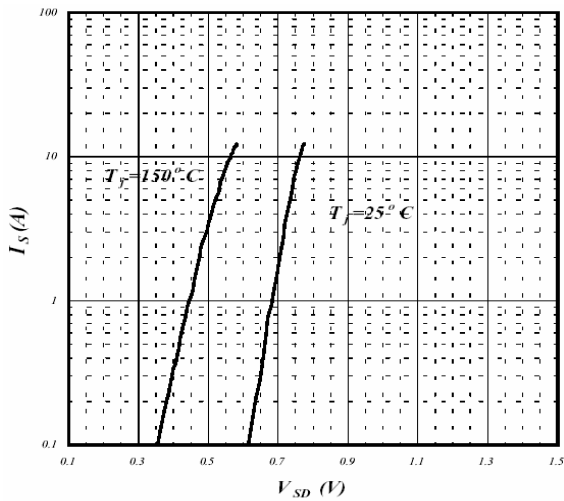

**Fig 11. Forward Characteristics of Reverse Diode**

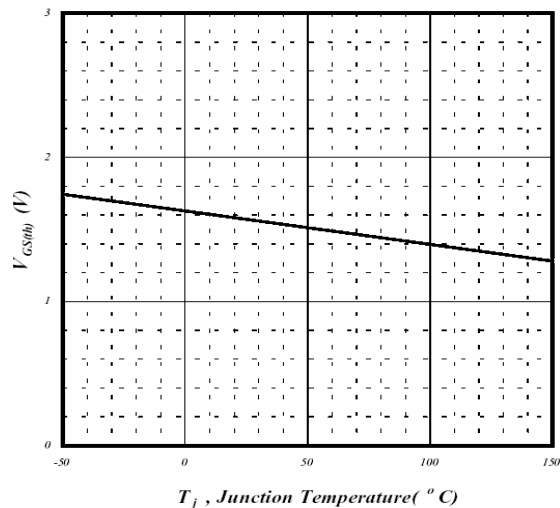

**Fig 12. Gate Threshold Voltage v.s. Junction Temperature**

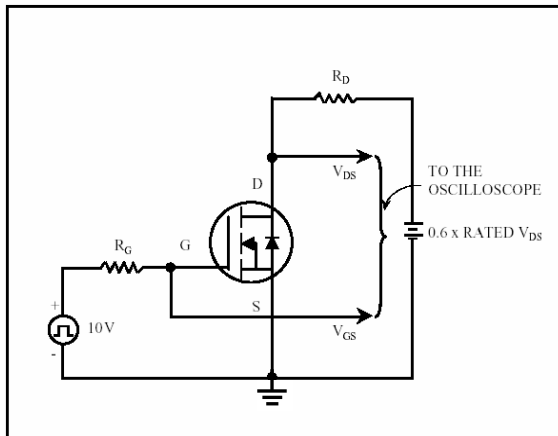

**Fig 13. Switching Time Circuit**

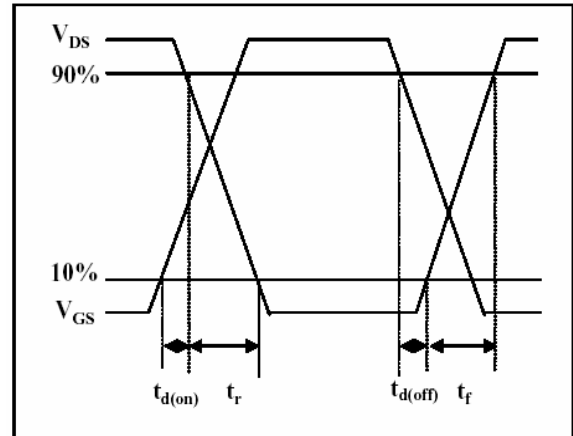

**Fig 14. Switching Time Waveform**

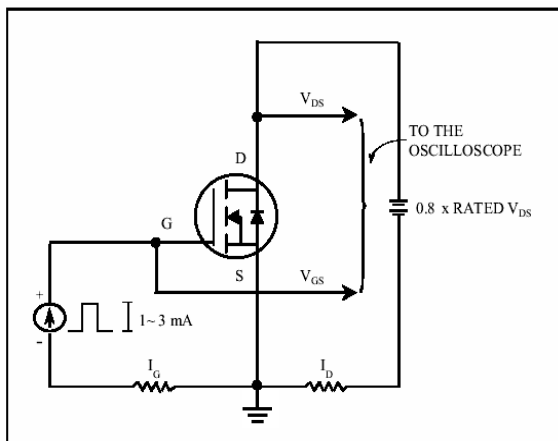

**Fig 15. Gate Charge Circuit**

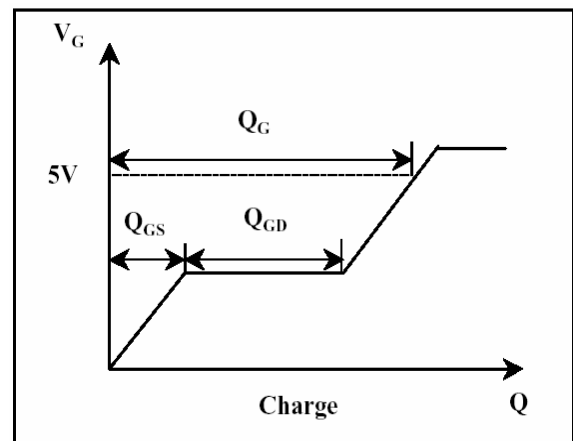

**Fig 16. Gate Charge Waveform**

**Important Notice:**

- All rights are reserved. Reproduction in whole or in part is prohibited without the prior written approval of GTM.
- GTM reserves the right to make changes to its products without notice.
- GTM semiconductor products are not warranted to be suitable for use in life-support Applications, or systems.
- GTM assumes no liability for any consequence of customer product design, infringement of patents, or application assistance.

**Head Office And Factory:**

- **Taiwan:** No. 17-1 Tatung Rd. Fu Kou Hsin-Chu Industrial Park, Hsin-Chu, Taiwan, R. O. C.
- TEL : 886-3-597-7061 FAX : 886-3-597-9220, 597-0785
- **China:** (201203) No.255, Jang-Jiang Tsai-Lueng RD. , Pu-Dung-Hsin District, Shang-Hai City, China
- TEL : 86-21-5895-7671 ~ 4 FAX : 86-21-38950165