

GT2133

CMOS Positive Voltage Regulator

Description

The GT2133 series of positive, linear regulators feature low quiescent current (30µA typ.) with low dropout voltage, making them ideal for battery applications.

The space-saving SOT-26 package is attractive for "Pocket" and "Hand Held" applications.

This rugged device has both Thermal Shutdown, and Current Fold-back to prevent device failure under the "Worst" of operating conditions.

An additional feature is a "Power Good" detector, which pulls low when the output is out of regulation. In applications requiring a low noise, regulated supply, place a 1000pF capacitor between Bypass and ground.

The GT2133 is stable with an output capacitance of 2.2µF or greater.

Features

- Very Low Dropout Voltage
- Guaranteed 300mA output
- Over-Temperature Shutdown
- Current Limiting
- Short Circuit Current Fold-back
- Typical Accurate ± 1.5%
- Noise Reduction Bypass Capacitor
- Power-saving Shutdown Mode
- Power Good Detector
- Factory Pre-set Output Voltages
- Low Temperature coefficient

Applications

- Battery Powered Widgets
- Instrumentation
- Wireless Devices
- PC Peripherals
- Portable Electronics
- Cordless Phones
- Electronic Scales

Functional Block Diagram

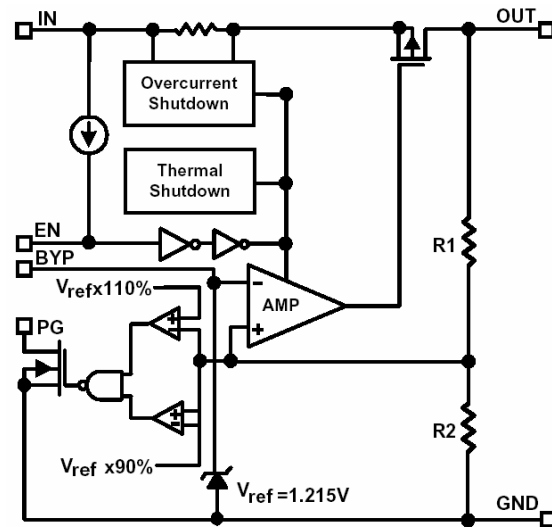

Package Dimensions

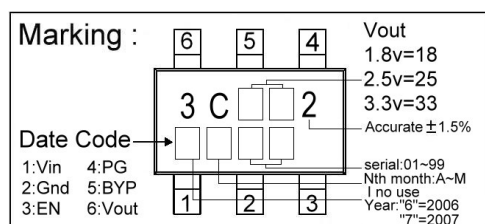
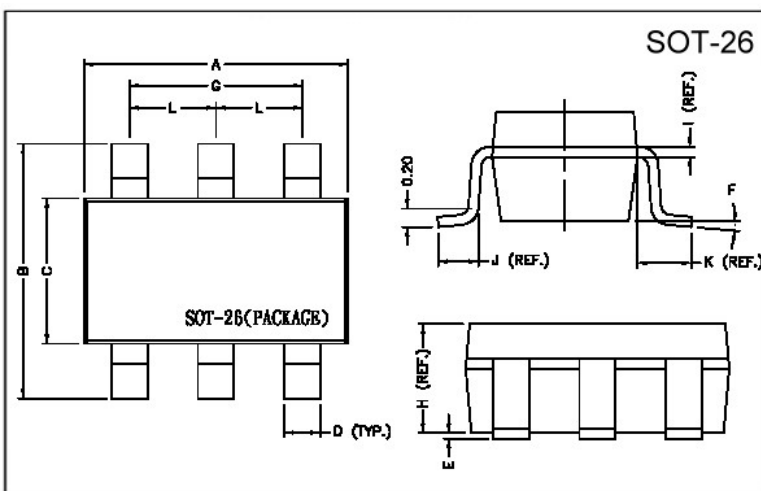

REF.	Millimeter		REF.	Dimensions	
	Min.	Max.		Millimeter	
A	2.70	3.10	G	1.90	REF.
B	2.60	3.00	H	1.20	REF.
C	1.40	1.80	I	0.12	REF.
D	0.30	0.55	J	0.37	REF.
E	0	0.10	K	0.60	REF.
F	0°	10°	L	0.95	REF.

Typical Application Circuit

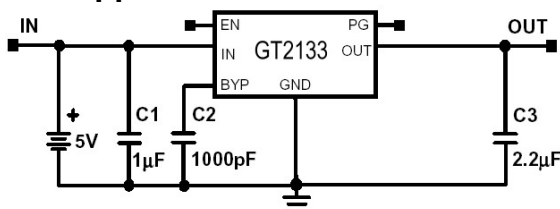

Absolute Maximum Ratings

Parameter	Symbol	Ratings	Unit
Input Max Voltage	V _{IN}	8	V
Output Current	I _{OUT}	P _D /(V _{IN} -V _O)	mA
Input, Output Voltage		GND-0.3 to V _{IN} +0.3	V
Operating Ambient Temperature	T _{opr}	-40 ~ +85	°C
Junction Temperature	T _j	-40 ~ +125	°C
Maximum Junction Temperature	T _{j Max}	150	°C
Thermal Resistance	θ _{ja}	260	°C/W
Power Dissipation(ΔT=100°C)	PD	380	mW
EDS Classification		B	

Electrical Characteristics Ta=25°C unless otherwise noted

Parameter	Symbol	Condition	Min	TYP	Max	Unit	
Output Voltage	V _{OUT(E)} (Note1)	V _{IN} =V _{OUT(T)} +2V, I _O =1mA	-1.5%	V _{OUT(T)} (Note2)	1.5%	V	
Output Current	I _O	V _{IN} =V _{OUT(T)} +2V, V _O >1.2	300	-	-	mA	
Current Limit	I _{LIM}	V _{IN} =V _{OUT(T)} +2V, V _O >1.2	300	450	-	mA	
Load Regulation	REG _{LOAD}	V _{IN} =V _{OUT(T)} +2V, I _O =1mA to 300mA	-1	0.2	1	%	
Dropout Voltage	V _{DROPOUT}	I _O =300mA V _O =V _{OUT(E)} -2%	1.2V ≤ V _{OUT(T)} ≤ 2.0V	-	-	1300	mV
			2.0V < V _{OUT(T)} ≤ 2.8V	-	-	400	
			2.8V < V _{OUT(T)}	-	-	300	
Quiescent Current	I _Q	V _{IN} =V _{OUT(T)} +1V, I _O =0mA	-	30	50	μA	
Ground Pin Current	I _{GNND}	V _{IN} =V _{OUT(T)} +2V, I _O =1mA~300mA	-	35	-	μA	
Line Regulation	REG _{LINE}	I _O =1mA V _{IN} =V _{OUT(T)} +1 to V _{OUT(T)} +2	1.2V ≤ V _{OUT(T)} ≤ 1.4V	-0.2	-	0.2	%
			1.4V < V _{OUT(T)} ≤ 2.0V	-0.15	-	0.15	
			2.0V < V _{OUT(T)} < 4.0V	-0.1	0.02	0.1	
			4.0V ≤ V _{OUT(T)}	-0.4	0.2	0.4	
Input Voltage	V _{IN}		Note3	-	7	V	
Over Temperature Shutdown	OTS		-	150	-	°C	
Over Temperature Hysteresis	OTH		-	30	-	°C	
Vo Temperature Coefficient	TC		-	30	-	ppm/°C	
Short Circuit Current(Note4)	I _{SC}	V _{IN} =V _{OUT(T)} +1V, V _O <0.8V	-	150	300	mA	
Power Supply Rejection	PSRR	V _{IN} =V _{OUT(T)} +2V I _O =100mA C _O =2.2μF	f=1kHz	-	50	-	dB
			f=10kHz	-	20	-	
			f=100kHz	-	15	-	
Output Voltage Noise	e _N	f=10Hz~100kHz I _O =10mA		30	-	μVrms	
EN Input Threshold	V _{EH}	V _{IN} =2.7V to 7V	2.0	-	V _{IN}	V	
	V _{EL}	V _{IN} =2.7V to 7V	0	-	0.4	V	
EN Input Bias Current	I _{EH}	V _{EN} =V _{IN} , V _{IN} =2.7V to 7V	-	-	0.1	μA	
	I _{EL}	V _{EN} =0V, V _{IN} =2.7V to 7V	-	-	0.5	μA	
Shutdown Supply Current	I _{SD}	V _{IN} =5V, V _O =0V, V _{EN} <V _{EL}	-	0.5	1	μA	
Shutdown Output Voltage	V _{O,SD}	I _O =0.4mA, V _{EN} <V _{EL}	0	-	0.4	V	
Output Under Voltage	V _{UV}	2.5V ≤ V _{OUT(T)} ≤ 5.0V	-	-	85	% V _{OUT(T)}	
		1.2V ≤ V _{OUT(T)} < 2.5V	-	-	75		
Output Over Voltage	V _{OV}	2.5V ≤ V _{OUT(T)} ≤ 5.0V	115	-	-	% V _{OUT(T)}	
		1.2V ≤ V _{OUT(T)} < 2.5V	125	-	-		
PG Leakage Current	I _{LC}	V _{PG} =7V	-	-	1	μA	
PG Voltage Rating	V _{PG}	V _O in regulation	-	-	7	V	
PG Voltage Low	V _{OL}	I _{SINK} =0.4mA	-	-	0.4	V	

Note 1: V_{OUT(E)} =Effective Output Voltage (i.e. the output voltage when "V_{OUT(T)} + 2.0V" is provided at the V_{IN} pin while maintaining a certain I_{OUT} value).

2: V_{OUT(T)} =Specified Output Voltage

3: V_{IN(MIN)} =V_{OUT}+V_{DROPOUT}

4: To prevent the Short Circuit Current protection feature from being prematurely activated, the input voltage must be applied before a current source load is applied.

Ordering Information (contd.)

Part Number	Marking	Output Voltage	Part Number	Marking	Output Voltage
GT2133-15	3C152 XXXX	1.5V	GT2133-18	3C182 XXXX	1.8V
GT2133-25	3C252 XXXX	2.5V	GT2133-27	3C272 XXXX	2.7V
GT2133-28	3C282 XXXX	2.8V	GT2133-29	3C292 XXXX	2.9V
GT2133-30	3C302 XXXX	3.0V	GT2133-31	3C312 XXXX	3.1V
GT2133-33	3C332 XXXX	3.3V	GT2133-34	3C342 XXXX	3.4V
GT2133-35	3C352 XXXX	3.5V	GT2133-36	3C362 XXXX	3.6V
GT2133-37	3C372 XXXX	3.7V	GT2133-38	3C382 XXXX	3.8V
GT2133-2H	3C2H2 XXXX	2.85V			

Detailed Description

The GT2133 family of COMS regulators contain a PMOS pass transistor, voltage reference, error amplifier, over-current protection, thermal shutdown and Power Good detection circuitry.

The P-channel pass transistor receives data from the error amplifier, over-current shutdown, and thermal protection circuits. During normal operation, the error amplifier compares the output voltage to a precision reference. Over-current and Thermal shutdown circuits become active when the junction temperature exceeds 150°C, or the current exceeds 300mA. During thermal shutdown, the output voltage remains low. Normal operation is restored when the junction temperature drops below 120°C.

The GT2133 switches from voltage mode to current mode when the load exceeds the rated output current. This prevents over-stress. The GT2133 also incorporates current fold-back to reduce power dissipation when the output is short circuited. This feature becomes active when the output drops below 0.8 volts, and reduces the current flow by 65%. Full current is restored when the voltage exceeds 0.8 volts.

External Capacitors

The GT2133 is stable with an output capacitance to ground of 2.2µF or greater. Ceramic capacitors have the lowest ESR, and will offer the best AC performance. Conversely, Aluminum Electrolytic capacitors exhibit the highest ESR, resulting in the poorest AC response. Unfortunately, large value ceramic capacitors are comparatively expensive. One option is to parallel a 0.1µF ceramic capacitor with a 10µF Aluminum Electrolytic. The benefit is low ESR, high capacitance, and low overall cost.

A second capacitor is recommended between the input and ground to stabilize Vin. The input capacitor should be at least 0.1µF to have a beneficial effect.

A third capacitor can be connected between the BY-Pass pin and Gnd. This capacitor can be a low cost Polyester Film variety between the value 0.001 ~ 0.01µF. A large capacitor improves the AC ripple rejection, but also makes the output come up slowly. This "Soft" turn-on is desirable in some applications to limit turn-on surges.

All capacitors should be placed in close proximity to the pins. A "Quiet" ground termination is desirable. This can be achieved with a "Star" connection.

Enable

The Enable pin normally floats high. When actively, pulled low, the PMOS pass transistor shuts off, and all internal circuits are powered down. In this state, the quiescent current is less than 1µA. This pin behaves much like an electronic switch.

Power Good

The GT2133 includes the Power Good feature. When the output is not within ±15% of the specified voltage, it pulls low. This can occur under the following conditions:

- 1) Input Voltage too low.
- 2) During Over-Temperature.
- 3) During Over-Current.
- 4) If output is pulled up.

(Note: PG pin is an open-drain output.)

Characteristics Curve

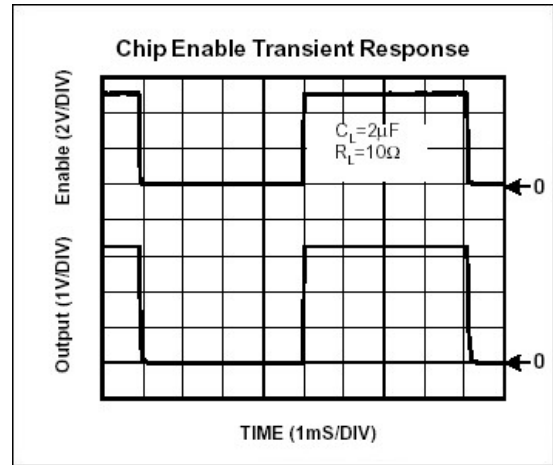
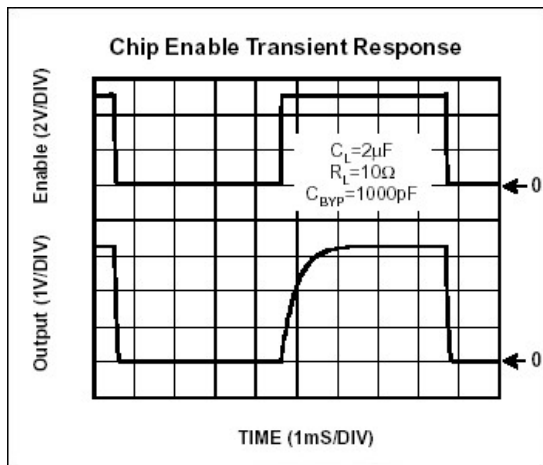
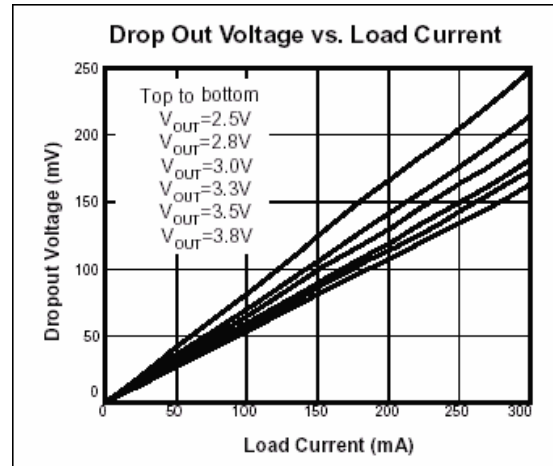
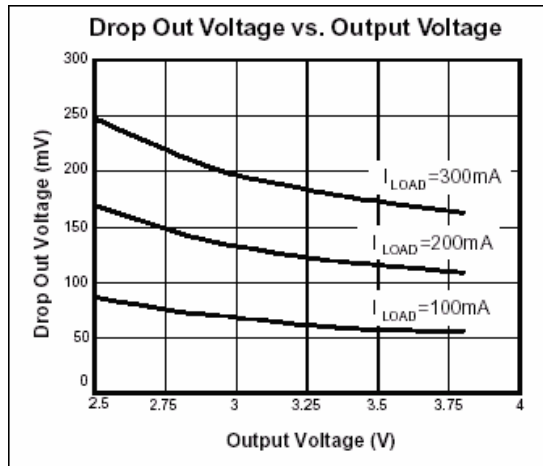
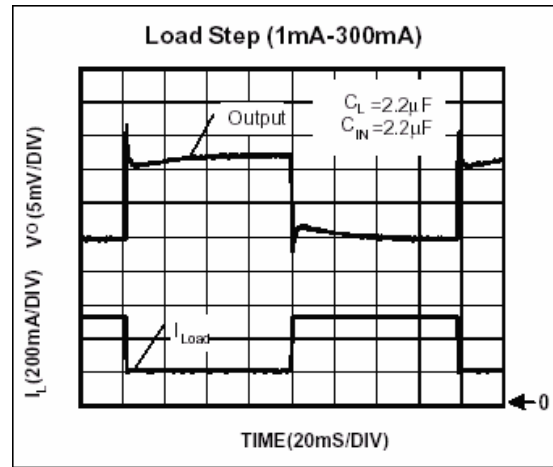
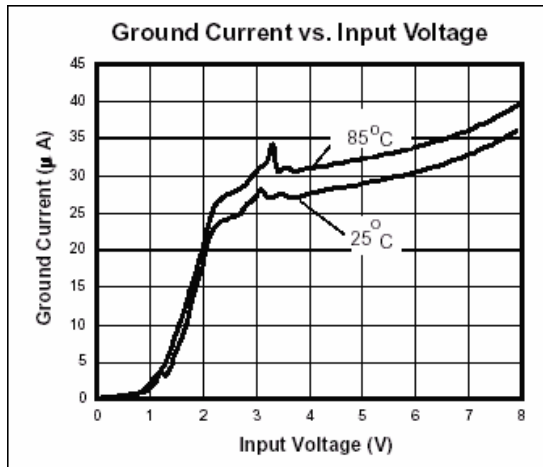

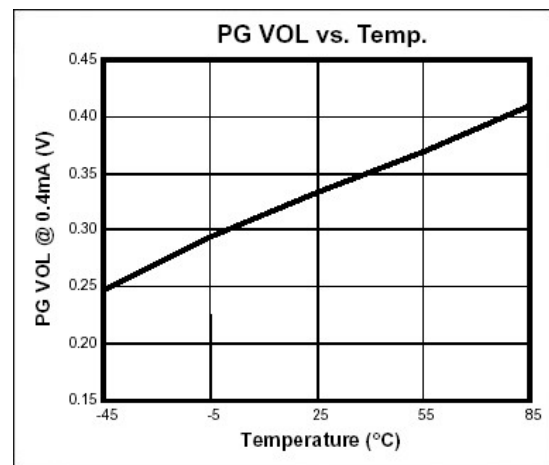
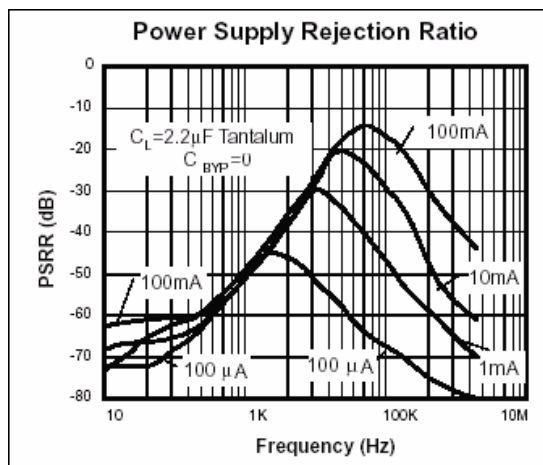
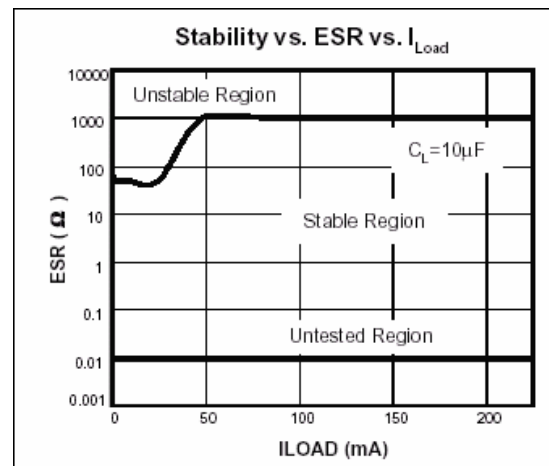
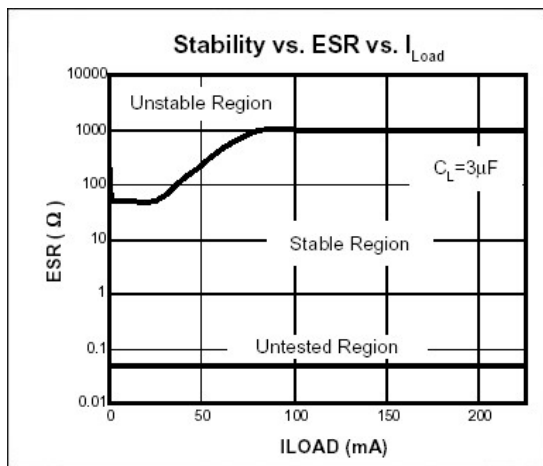
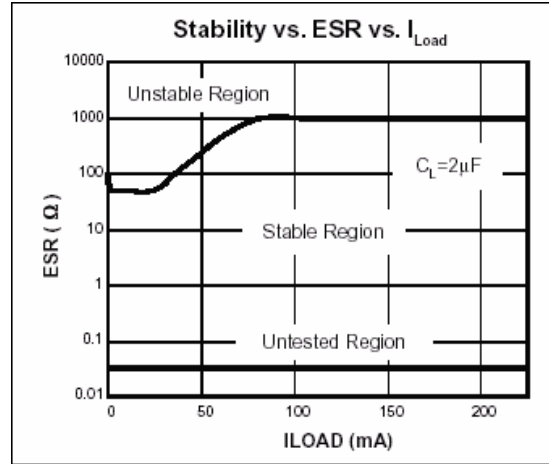
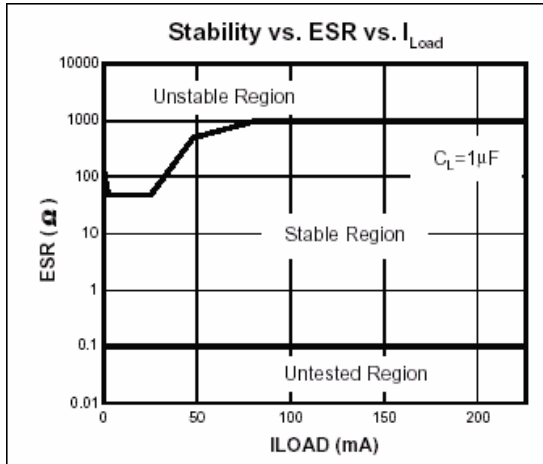

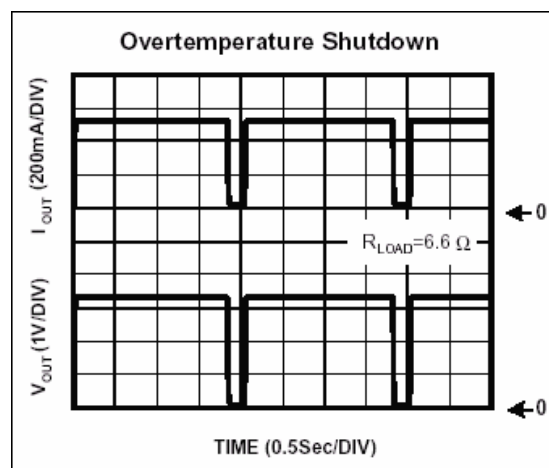
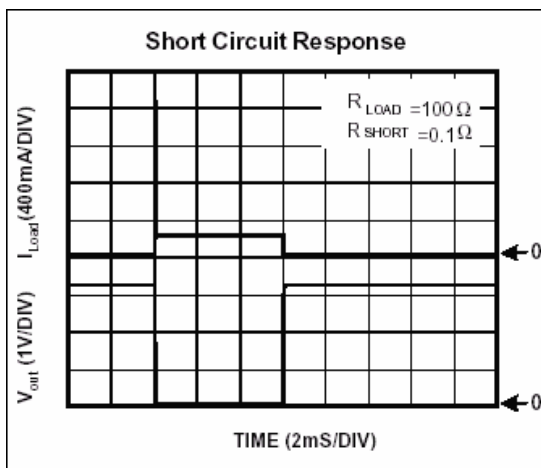
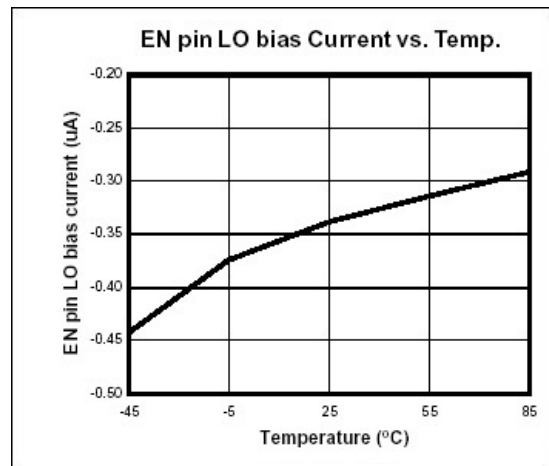
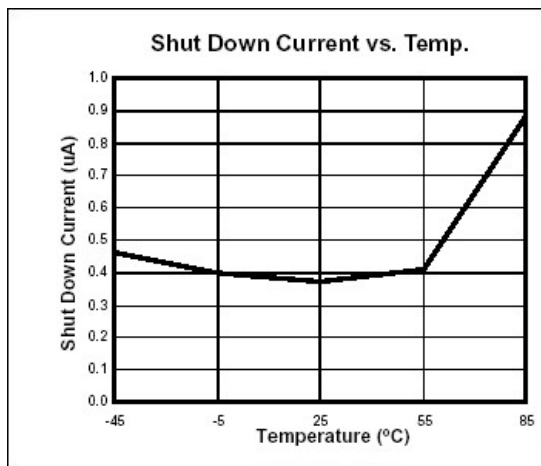
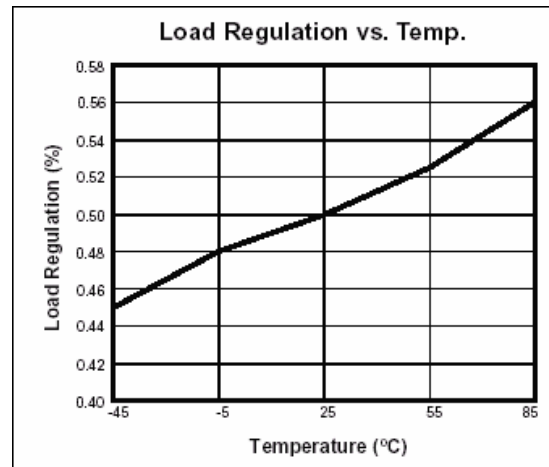
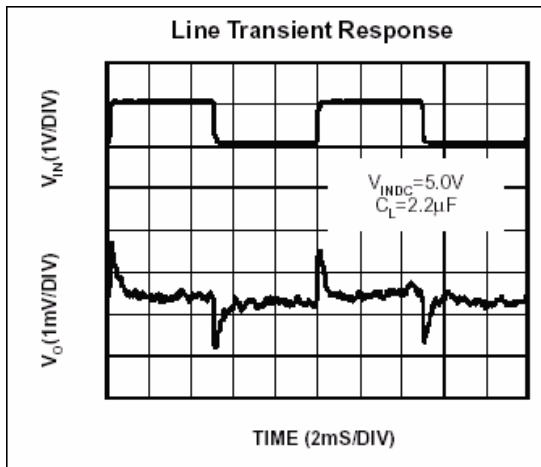

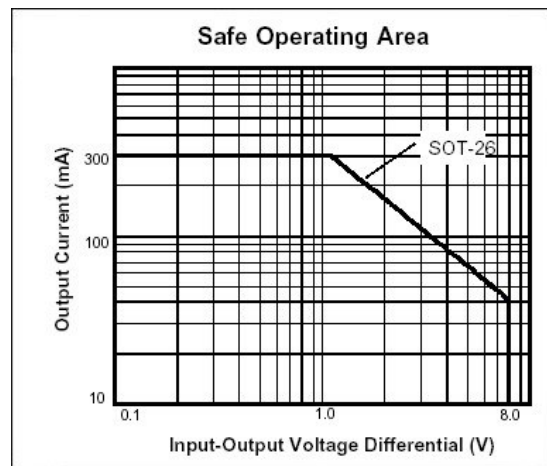
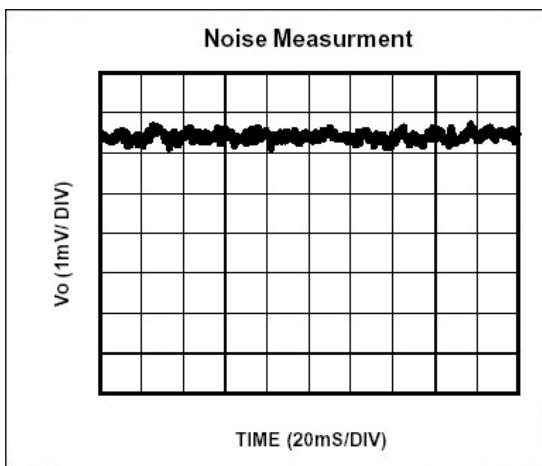
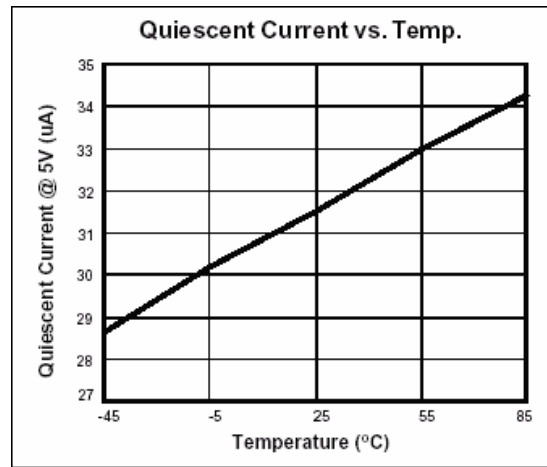
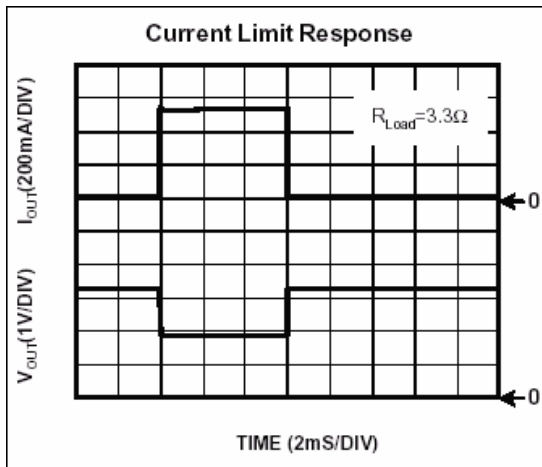

Important Notice:

- All rights are reserved. Reproduction in whole or in part is prohibited without the prior written approval of GTM.
- GTM reserves the right to make changes to its products without notice.
- GTM semiconductor products are not warranted to be suitable for use in life-support Applications, or systems.
- GTM assumes no liability for any consequence of customer product design, infringement of patents, or application assistance.

Head Office And Factory:

- **Taiwan:** No. 17-1 Tatung Rd. Fu Kou Hsin-Chu Industrial Park, Hsin-Chu, Taiwan, R. O. C.
- TEL : 886-3-597-7061 FAX : 886-3-597-9220, 597-0785
- **China:** (201203) No.255, Jang-Jiang Tsai-Lueng RD. , Pu-Dung-Hsin District, Shang-Hai City, China
- TEL : 86-21-5895-7671 ~ 4 FAX : 86-21-38950165